

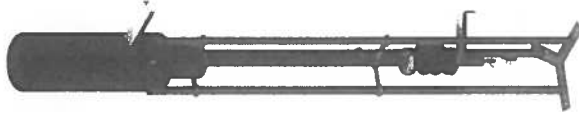

# Manual Gas Flare FAI



## Installation Manual

The Bilgeri EnvironTec GmbH reserves the right to make changes at any time, in order to adapt the operating manual to the current state of technology.

Copying and distributing this operating manual, or excerpts thereof also its translations, requires the written approval from Bilgeri EnvironTec GmbH.

All trademarks mentioned in this operating manual and its respective proprietors are acknowledged. Bilgeri EnvironTec GmbH does not lay any claims to the rights of these trademarks.

The scope of delivery and delivery execution may deviate from the illustration on the title page.

Article number of this installation number: FAI\_ENG\_v2014-02



**Bilgeri EnvironTec GmbH**

Schilfweg 1  
A- 6972 Fussach  
Telefon: +43 (0) 55 78 7 70 05  
Fax: +43 (0) 55 78 7 70 05-300  
E-Mail: [info@environtec.at](mailto:info@environtec.at)  
Internet: [www.environtec.at](http://www.environtec.at)

© 2013  
Status: 2013, translation of the original  
All rights reserved

Printed in Austria.

**Contents:**

1. GENERAL.....	5
1.1 To the operating personnel.....	5
1.2 Supporting documents.....	5
1.3 Safekeeping this manual.....	5
1.4 To understand this manual better.....	5
2. Safety.....	6
2.1 Correct use.....	6
2.2 Improper use.....	7
2.3 Operating personnel qualification.....	7
2.4 Warning, mandatory and information signs on the device.....	8
2.5 Basic safety instructions.....	9
2.6 Due diligence of operator.....	10
2.7 Product liability.....	11
3. Aufbau und Funktion.....	12
3.1 General information.....	12
3.2 Assembly.....	<b>Fehler! Textmarke nicht definiert.</b>
3.3 Functional principle of the gas flare.....	13
3.4 Gas flare, standard components.....	13
3.4.1 Hauptkomponenten, mechanisch.....	<b>Fehler! Textmarke nicht definiert.</b>
3.4.2 Main components, electric, control.....	16
3.5 Gas flare, add-on equipment and options.....	18
4. Transportation and storage.....	19
4.1 Transport.....	19
4.2 Storage.....	19
5. Lieferumfang.....	<b>Fehler! Textmarke nicht definiert.</b>
5.1 Gas flare FAI.....	20
5.2 accessories.....	20
6. Identification plate.....	21
6.1 Identification plate gas flare FAI.....	21
7. technical data.....	22
7.1 Gas flare general information.....	22
7.2 Gas flare by model size.....	22
7.3 Accessories.....	22
8. Installation.....	23
8.1 Place of use.....	23
8.2 Installation and setup.....	24
8.3 After installation and before initial start up.....	28
9. Start up and operation.....	30
9.1 Initial start up.....	30
9.2 Start-up.....	31

9.3 Operation.....	32
9.4 Taking out of operation.....	34
10. Malfunctions and removal malfunctions.....	35
10.1 Behaviour in case of malfunctions.....	35
10.2 Troubleshooting.....	35
11. Maintenance.....	37
11.1 Safety during maintenance.....	37
11.2 Record.....	37
11.3 Inspektions- und Wartungsplan.....	38
11.4 Torques.....	39
11.5 Inspection and maintenance work.....	39
11.6 Restart.....	44
11.7 Spare and wearing parts.....	44
12. Appendix.....	45
12.1 Checklist for initial start-up.....	45
12.2 Proof of repair work and leak tests.....	46
12.3 Annex.....	47

## 1. GENERAL

### 1.1 To the operating personnel

This operating manual informs about the safety, assembly, function, operation and maintenance of the gas flare. If properly following the instruction, a long, trouble free and safe operation is guaranteed.

### 1.2 Supporting documents

See Annex

### 1.3 Safekeeping this manual

The manual (including supporting documents) is always kept in legible condition, available completely at the operating location!

### 1.4 To understand this manual better

#### Conventions

##### **▲GEFAHR**

This danger symbol refers to an imminent threatening, serious, danger, which leads with certainty to serious injuries or even to death, if the danger is not avoided.

##### **!**

This danger symbol refers to a possible danger, which can lead to serious injuries or even to death, if the danger is not avoided.

##### **▲VORSICHT**

This danger symbol refers to a potentially, dangerous situation, which can lead to medium or light injuries or property damages, if it is not avoided.

##### **HINWEIS**

This symbol refers to supporting information.

#### Cross-references

Cross references are presented in *italics*.

## 2. SAFETY

The Bilgeri EnvironTec GmbH gas flares are designed and constructed taking into consideration the highest safety requirements, and upon carefully choosing other matching standards to follow, as well as other technical specifications. It meets the current state of technology and guarantees the highest measure of safety. However, in operating conditions this safety can only be achieved if all necessary measures are followed. It is subject to the due diligence of the operator to plan and execute these measures and to control its execution.

### 2.1 Correct use

The gas flares of type FAI are conceptualized for burning of explosive gases of the Group IIA temperature class T1 (methane with CO2 biogas plants or water treatment plants).

##### **▲GEFAHR**

#### Danger of explosion!

The FAI type gas flare is only permitted for using outside of the Ex zones.

- From the customer side it must be made sure that unintentional operation in and explosive atmosphere is safely prevented. See *operator Ex-protection zone plan*.
- The operation of the manual gasflare must be carried out under the supervision of the operating staffs! When uncontrolled flame extinction (eg by a gust of wind), butterfly valve must be closed immediately in order to prevent the further gas flow. Their starting procedure must be performed again.
- If automatic option is chosen, the gasflare is monitored automatically and the procedure described above is not applicable.

The burning of explosive gas/air mixtures in the gas flare is not permitted!

Any other use is considered as unauthorized and is thus explicitly prohibited.

The operator of the gas flare is responsible for all damages caused if not operating the unit properly!

Proper use includes:

- Following all notes in this operating manual
- following the mandatory, prohibition and warning signs on the system
- Complying with the inspection and maintenance intervals.

## 2.2 Improper use

If not using as instructed (improper use), for example:

- if not using in accordance with the conformity statement.
- incorrect installation in the system
- if the gas flare, including control cabinet are not ready for operation, or were modified
- by taking the safety devices out of operation
- by unauthorized access to the switch cabinet and wiring
- by using other types of gasses

...the system may be destroyed.

This results in the operator being exposed to incalculable increased danger potential, for example by:

- hot parts
- explosion
- electrocution
- uncontrolled gas leak
- creating an explosive atmosphere
- poisoning with health damaging gas components, etc.

The system must immediately be shut-down if there are any changes!

## 2.3 Operating personnel qualification

Only trained and instructed personnel is allowed to operate the gas flare. The completion of the instruction should be documented in writing.

Only a qualified electrical engineer is allowed to work on the electrical equipment!

## 2.4 Warning, mandatory and information signs on the device

The following signs can be found on the gas flare (DIN 4844):



Unauthorized access is prohibited!



Fire, open light and smoking is prohibited!



Warning of explosive atmosphere



Warning hot surface



Warning of dangerous electrical current



Observe operating manual

## 2.5 Basic safety instructions

The safety instructions are for purposes of avoiding personal injury and damaging the gas flare and our environment. All operators are obligated to read and always follow these safety instructions.

### General information

Please follow the safety rules, the relevant accident prevention rules for biogas plants and those for pits and channels, the national implementation of directive 99/92/EC, and other rules of technology.

In addition to the Operating Manual, the generally valid and local regulations on accident prevention, health and safety and the regulations on environmental protection must be readily available and followed.

People under the influence of alcohol, drugs or prescription medicine, may not transport, setup, start up, operate or repair the gas flare system.

The minimum age of operating personnel is 18 years.

Make sure that the operating personnel is instructed on all applicable questions concerning work safety and environmental protection, and that they understand and follow the operating manual, particularly the safety instructions contained therein.

Please follow all warning and information labels attached to the gas flare. Also ensure that such signs are not removed and always remain legible. (See above).

Defects to the gas flare must be removed immediately. The manufacturer must be notified immediately in the event of malfunction. Do not make any changes or reconstruction yourself.

When exchanging defective components, use only original components with the same electrical and mechanical data. Otherwise, this will not maintain safety and function.

All safety equipment, fasteners and electrical connections and lines must be checked regularly for proper condition.

Unrestricted access to the gas flare by people or animals must be prevented with suitable means (e.g. safety fence).



### Danger of electric shock!

Electrical work is may only be performed by qualified electrical engineers. An electrical engineer is someone, who based on professional education, knowledge and experiences, as well as knowledge of the relevant regulations of the assigned work, is able to recognize potential dangers and take appropriate safety measures.

- When working on starter electrodes, it is mandatory to operate the emergency shut-off switch, or safely interrupt the power supply. Please also stop the gas supply by closing the manual flap.
- Before working in the switch cabinet, make sure to shut-off the power supply, and secure it from unintentionally switching back on, and attach the respective warning sign.



### Warning of risk of explosion and flammable atmosphere!

Installation and repair work on systems protected from explosion is completed by personnel appropriately trained who follow the 99/92/EC directive and the safety and maintenance instructions of this operating manual.



### Risk of burns!

Caution! Methane flames are invisible

- Shut-off the system before working on the burner or ignition electrodes.
- Make sure that all parts are completely cooled off.

### Fire Hazard!

The safety distance to prevent damage by fire impact on buildings and surfaces of stationary traffic should be 5 m - provided not otherwise stated in relevant local fire protection provisions.

- the 5m surrounding area around the gas flare must be kept free of any growth (bushes, trees). Within this safety distance, fire, open light, smoking and storing of flammable or ignitable materials is prohibited.

In justified exceptional cases these distances may be reduced, if other measures for avoiding fire impact are ensured for the surrounding area.

## 2.6 Due diligence of operator

As the operator, you must especially make sure that

- the gas flare is only used as instructed.
  - The gas flare is only operated when functioning properly, and especially that the function of the safety equipment is checked regularly. If there is damage or destruction, or a risk-free operation of the gas flare cannot be guaranteed for other reasons, then the system must immediately be taken out of operation and may under no circumstance be put back into operation.
  - The necessary personal protective equipment is available and is used by the operating, maintenance and repair personnel.
  - The instruction manual is always in legible condition and available completely at the operating location.
  - Only adequately qualified and authorized personnel may operate, maintain and repair the system. The personnel is regularly instructed in all questions concerning work safety and environmental protection, understands the operating manual and especially the safety instructions contained therein.
- All safety and warning signs attached to the gas flare are not removed and remain legible.

EnvironTec GmbH will not assume any responsibility for damages or operating malfunctions that have been created by improper use or gross negligence.

## 2.7 Product liability

### Liability exclusions

For personal injury, property damage, environmental and/or operating damages caused by not following, or not completely following the operating manual, Bilgeri EnvironTec GmbH will not assume liability. Unauthorized contact with the system will result in termination of the warranty. Bilgeri EnvironTec GmbH will not assume liability or warranty, if another spare part is used instead of the original spare part recommended in the operating manual or in the spare part list, and the use of non-original spare parts has led to personal injury, material damages and/or failure of the system.

Warranty and liability claims for personal injury, property and environmental damages are excluded if the damage or injury is attributable to one or more of the following causes:

- Improper transportation, assembly, start-up, operation or repair of gas flare
- Not observing the instructions in the operating manual regarding assembly, start-up, operation and maintenance.
- Unauthorized contact or structural changes of the gas flare
- Poor monitoring of parts that are subject to wear or aging
- Improperly completed repairs
- Improper use of the gas flare

### HINWEIS

The descriptions and instructions in this operating and maintenance manual refer to the standard designs. Therefore, not all details and conditions have been mentioned. If missing information, please contact EnvironTec GmbH immediately.

*For details about our warranty please refer to our general terms and conditions, or your agreement documentation.*

## 3. COMPONENTS AND USE

### 3.1 General information

When operating biogas or water treatment plants it may be necessary under certain circumstances to safely burn excess gas, for example during start-up, maintenance, in cases of consumer accidents or in case of failure of gas flow (CHP [Cogeneration Unit], etc.).

The FAI gas flare is a safety device that functions manually (optional: fully automatic). It is manufactured completely from stainless steel and equipped with high quality components and instruments.

### Safety Features

With the respective dimensioning of the flow cross-sections, blowing out or return of the flame is prevented. If the flame should return anyway, it is stopped by the deflagration protection. Damage to other systems parts its thus excluded.

The entire electrical equipment was configured according to DIN VDE 0116, and meets the highest safety engineering standards.

### 3.2 Structure

The gas flare can be obtained in various sizes. See 7.2 Gas flare by model size.

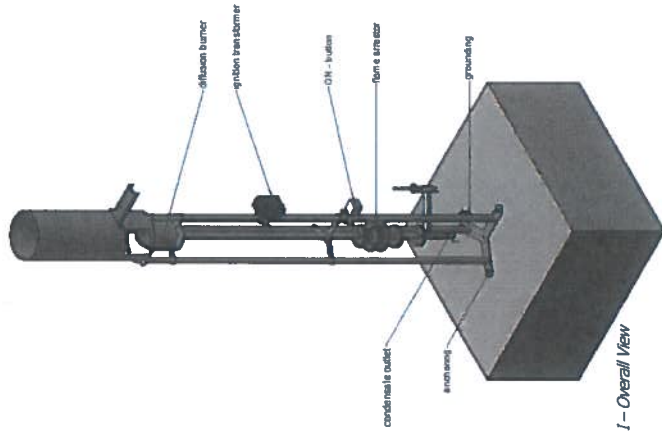

Fig. 1: EnvironTec Flare FAI – Overall View

### 3.3 Functional principle of the gas flare

#### Manual operation

To start the flare, first the butterfly valve must be opened and the ON button must be pressed immediately after. Pressing the on button will start the flare and the flare starts burning. After the flare starts burning, stop pressing on the ON button. To stop the flare, close the butterfly valve.

#### Automatic operation (Option)

The start/stop command is issued by an external signal (e.g. gas storage fill level). The monitoring/automatic functions described for the hand operation will take place as described above.

#### Automatic operation / pressure control (Option)

As an option the flare may be equipped with an additional pressure control. If exceeding the pressure previously defined on the pressure controller (=max. controller), the flare starts automatically (as in normal automatic operation). If the pressure falls below the specified shut-off pressure (=min. pressure controller), the flare is automatically shut off (time delayed).

The functions of the hand and automatic operation will proceed as described above.

### 3.4 Gas flare standard components

#### 3.4.1 Principal mechanical components

##### Butterfly valve

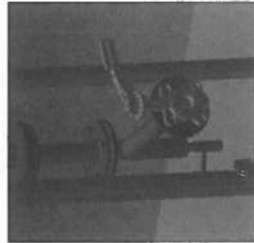

Fig. 2: butterfly valve

The manual valve is used for manually opening and closing the gas supply lines for repairs or when taking out of operation as an additional shut-off valve. It is equipped with a hand lever and an opening regulator.

##### Deflagration-protection



Fig. 3: Deflagration protection in the installation positions, flame filter in detail

Prevents the effective creation of pipe deflagrations (accelerates deflagration in the piping, which is moving in the pipe axle direction with a flame extension speed below the sound of speed).

A statically dry flame protector made of spiralled bound metal bands with flame extinguishing gaps is used. The flame is extinguished by heat output in the boundary layer "s" to the larger surface of the gap, in relation to the gap width D and lowering the temperature below the ignition temperature of the product.

As an option, the deflagration protection may be equipped with a temperature gauge on the "hot" side.

##### Burner head / combustion chamber

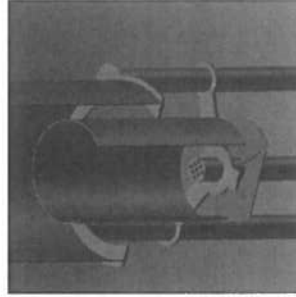

Fig. 4: View burner head in the combustion chamber

By default one (or more) diffusion burner heads are used. There is a mixture of fuel and oxidant (air) in the combustion chamber. The mixing is essentially completed by diffusion and leads to the formation of a diffusion flame. Below the burner head, there is an air disc to regulate the air flow.

The burner heads are replaceable and are manufactured from temperature resistant stainless steel.

##### Flare base, piping and combustion chamber

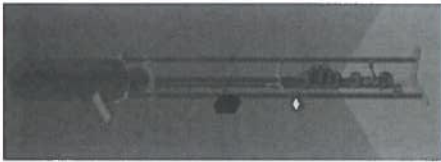

Fig. 5: Overall view of the flare base, piping and combustion chamber

The entire gas flare is manufactured from stainless steel. The base and frame, as well as no gaswelded parts are from material 1.4301, the entire gas piping and the combustion chamber of material 1.4571.

**Anchoring**

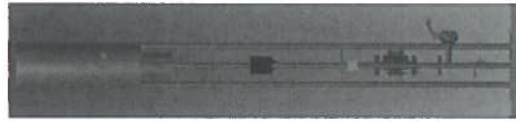

Fig. 6: view of the anchoring

The gas flare is anchored using a heavy load anchor system on the foundation anchored by the customer side.

**3.4.2 Main components, electric, control  
Ignition electrodes**

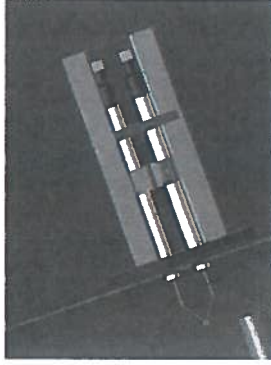

Fig. 7: Ignition electrodes in installation condition, view from the bottom

The combustion gas is ignited directly above the burner head by means of two high voltage ignition electrodes. An electric arc is generated between the ignition electrodes, which under normal circumstances will immediately ignited the gas mixture.

**Control / switch cabinet (option)**

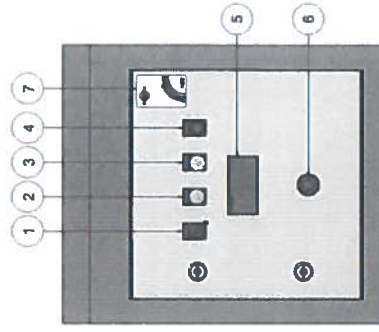

Fig. 8: Switch cabinet – view of the door with lights and switches

- 1 Switch: Manual-OFF-Automatic
- 2 Signal lamp motor valve open (optional)
- 3 Singnal lamp operating (optional)
- 4 Singnal lamp error or reset button
- 5 Display (optional)
- 6 Emergency stop button
- 7 Inspection tag

The most important control elements (SPS control module Omron, flame detector, ignition transformer, mode selector...) of the flare are stored in the flare switch cabinet and are interconnected / wired accordingly.



The switch cabinet is delivered in the series production made from plastic (protection type IP 54), including switch cabinet heating, emergency stop button (formerly emergency off button) and signal lamps. As an option the delivery may be made in a stainless steel design. As an option an automatic burner control could be chosen.

The power supply needed is 230 V, 50 Hz. The respective operating conditions of the gas flare are displayed by means of pilot lights on the switch cabinet.

**Communication** (only available if automatic option is taken)

The flare control can be directly incorporated in the control/visualization of the respective operating plant (biogas plant, digester gas, or similar). The following signals are planned for this purpose:

- |  |   |
|--|---|
| <p><b>Central Control – Gas Flare</b></p> <ul style="list-style-type: none"> <li>• external on or off (for "on" signal the flare signal "on" is withdrawn, it will stop)</li> <li>• Fault acknowledgement</li> </ul> | <p><b>Gas Flare – Central Control</b></p> <ul style="list-style-type: none"> <li>• Automatic valve open – without limit position monitoring/válvula automática abierta - sin control de límite de posición</li> <li>• Operating message</li> <li>• Malfunction</li> </ul> |
|--|---|

**Grounding connection**

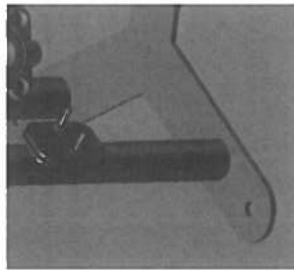

Fig. 9: Grounding connection of the gas flare (with identification label)

In the standard production the gas flare is equipped with a grounding connection to a gas flare base. From the customer side, the connection must be completed according to the local or national regulations.

### 3.5 Gas flare, add-on equipment and options

**Display on the flare switch cabinet**

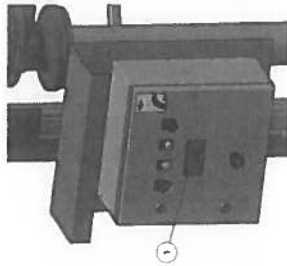

Fig. 10: Display on the switch cabinet  
1. Display

Optionally, a LCD display may be integrated in the flare switch cabinet. Depending on customer request /need displays about the current flare status, combustion temperature or other parameters may be implemented.

**Electrical heating of the fittings**

Generally, biogas is 100% humidity saturating. To prevent ice formation or freezing of the valves, an electrical support heater with thermostat may be used, and the fittings can be insulated additionally. For this purpose the valves and applicable piping sections are covered by a heating cable. The temperature control occurs via a thermostat in a manner that the fittings are always kept at > 0 °C. The heated system parts are then also insulated.

## 4. TRANSPORTATION AND STORAGE

### 4.1 Transport

The gas flare is packaged by EnvironTec GmbH ex works in a manner that it can be transported smoothly.

The gas flare is tied down flat on pallets. Small parts or valves > DN 150 are packed on the pallet separately.

The items are packaged in a manner that the gas flare can be accommodated and transported on site using a fork lift.

### 4.2 Storage

When storing the gas flare must be protected from dirt, dust and moisture.

## **⚠ VORSICHT**

### Risk of damaging the gas flare!

If not storing the gas flare properly penetrating moisture or small animals may cause damage.

- If storing on site for an extended period it must be made sure that the electrical components of the gas flare do not get in contact with the ground or possible puddles.
- The switch cabinet may also be protected from water.
- Open pipe ends or valves must be protected from water penetrating, or small animals, by means of protective flaps intended for this purpose.

## 5. SCOPE OF DELIVERY

The gas flare is available in the following model sizes:

- Gas flare FAI 50
- Gas flare FAI 100
- Gas flare FAI 150
- Gas flare FAI 300
- Gas flare FAI 500
- Gas flare FAI 600

Each model size is working with an operating pressure from 2,5-20mbar, but therefore the flow is changing by pressure.

### 5.1 Gas flare FAI

Element	Quantity
Gas flare, complete with all standard components See 3.4 Gas flare, standard components.	1
Befestigungsmaterial: 3 x heavy-load anchors for flare base fastening Installation manual	1 set
	1

### 5.2 Accessories

See 3.5 Gas flare, add-on equipment and options.

## 6. IDENTIFICATION PLATE

### 6.1 Identification plate gas flare FAI

Das Typenschild der Gasfackel is placed on the gas flare.



Fig. 11: The identification plate of the gas flare

When calling our customer service in case of malfunctions and for ordering spare parts, please provide us with the identification plate, the serial number and year built.

Other identification plates are found on the components.

## 7. TECHNICAL DATA

### 7.1 Gas flare general information

Gas primary pressure (mbar)	2,5 - 20
Heating value (kWh / Nm <sup>3</sup> )	= flow rate x 6,5
Medium *	Biogas (65% CH <sub>4</sub> , 34% CO <sub>2</sub> , 1% H <sub>2</sub> S)
Methane content (%)	45 – 70
Operating and control voltage	24 VDC (only if automatic mode is chosen)
Power supply	230 VAC, 50 Hz, others on request

\*The percentages listed are assumed biogas compositions common for biogas or digester gas plants.

### 7.2 Gas flare by model size (standard)

Model size	Ø Flame tube mm	Gas inlet DN	Max Flow rate	
			at 2,5 mbar Nm <sup>3</sup> /h	at 20 mbar Nm <sup>3</sup> /h
FAI 50	DM 350	40	50	80
FAI 100	DM 350	50	70	140
FAI 150	DM 450	65	150	230
FAI 300	DM 450	80	160	300
FAI 500	DM 636	100	250	530
FAI 600	DM 636	125	500	600
FAI 50 Auto	DM 350	40	40	80
FAI 100 Auto	DM 350	50	60	130
FAI 150 Auto	DM 450	65	130	210
FAI 300 Auto	DM 450	80	140	300
FAI 500 Auto	DM 636	100	230	510
FAI 600 Auto	DM 636	125	410	600

The information about the type specifications can be found in the prospectus sheet "Biogas Flare FAI".

### 7.3 Accessories

Description	Data	Comments
Switch cabinet	Stainless steel	
Display for flare status	LCD 2-lines	In the switch cabinet door

## 8. INSTALLATION



**Danger of personal injury, property and environmental damage!**

*Please follow the safety instructions in Chapter 2. Safety.*

### 8.1 Place of use



**Danger of explosion!**

The gas flare is not permitted to be used in Ex zones.

- When positioning the gas flare, please observe the ex zone plan of the biogas or digester system!

### Requirements

- The gas flare may only be setup outside.
- Additional roofing is not permitted.
- No wires (power etc.) may be run in the vicinity of the burner head or above it.
- Fire protection distances to buildings, areas of stationary traffic and bushes and trees must be maintained. For this purpose see the warning signs in Chapter 2.
- The manual shut-off flap must always be easily accessible without using any aids.
- To avoid risks of mechanical damage (e.g. with start-up), the traffic areas should be a safe distance away from the gas flare.
- The structure of the foundation (Static) for the gas flare may only be implemented according to the respective foundation drawings.
- When preparing the installation make sure that possible concrete fixtures (lines, etc.) are not damaged.

### HINWEIS

Make sure that for the gas flare location the gas line cannot freeze, i.e. no condensation may form and the gas line must have a slope adjusted for the terrain.

## 8.2 Installation and setup



**Danger of personal injury, property and environmental damage!**

Electrical and gas pressure engineering connection conditions must coincide with the information in Chapter "Technical Data".

### Electrical connection

The electrical connection may only be completed by instructed and qualified specialized engineering companies.

To reduce the probability of electrical corrosion, the entire electrical installation of the system should be designed in a network configuration TN-C-S or TN-S.

For operating the gas flare a wiring provided by the customer is necessary.

### Potential equalization

The customer side (operator) must ensure potential equalization

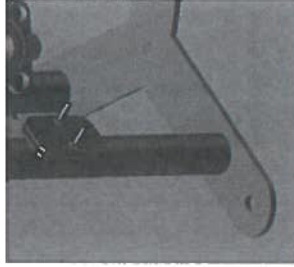

*Fig. 12: Grounding connection of the gas flare*

The standard release of the gas flare is equipped with a labelled grounding connection.

### Lightening protection

The customer (operator) must provide lightning protection.

### Gas connection

The electrical connection or gas pipe connection may only be completed by instructed and qualified specialized engineering companies.

**Assembly**

- Unload flare from truck / container, remove transport locks, place crane hook.
- Place a strap or steel cable and fasten it to the flare as showed in *Figure 13*.

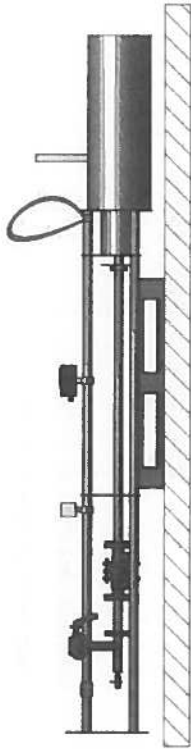

*Fig. 13: Strap fixation*

- Lift the flare until it is completely in vertical position

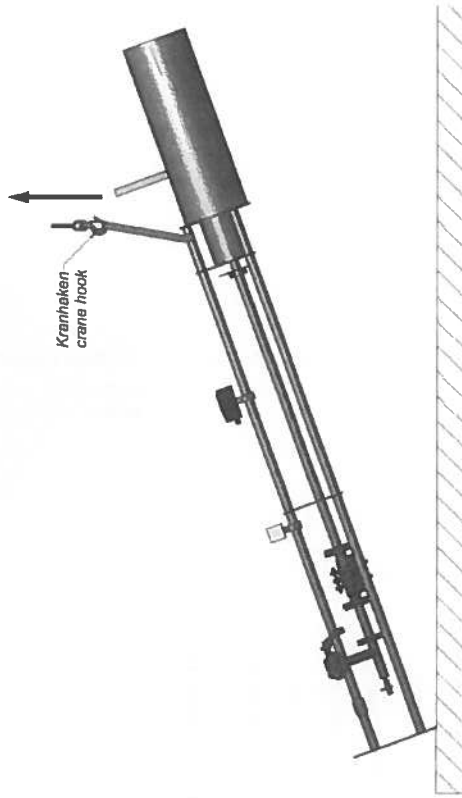

*Fig. 14: Flare lifting*

- Place the flare on the foundation.

**Attached gas flare**

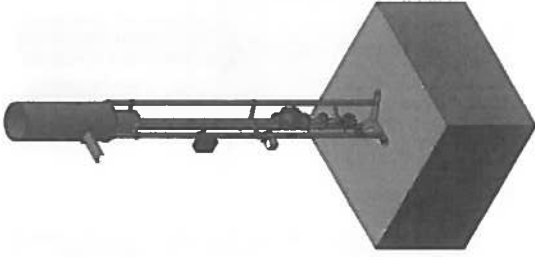

*Fig. 15: Attached gas flare*

- Vertically set gas flare on concrete foundation.

**⚠ VORSICHT**

**Danger of personal injury and property damage!**

There is risk of injury and damage to the gas flare, because of tipping before the gas flare is correctly attached to the concrete foundation, and is secured with guy ropes.

- Unhook crane hook only after fixing the anchor of the lift belt.



*Fig. 16: View of anchors*

- Attach gas flare with fix anchor M 16 (1) on the concrete foundation (2)

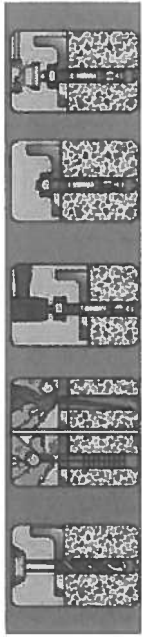

Fig. 17: Insert instruction for drop-in anchor.

Follow the insert instruction for drop-in anchor.

- Drill hole
- Clean hole bore
- Insert anchor
- Set anchor
- Set torque

**Connect gas flare**

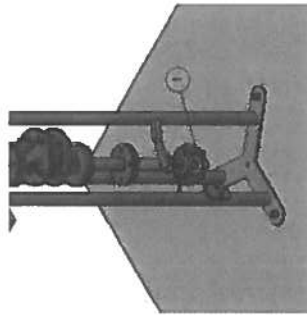

Fig. 18: Connect gas flare

- Attach flange piece (2) and manual fold (1).
- Connect manual gas flap with gas pipe.

**8.3 After installation and before initial start up**

**Settings**

**Electrode distances**

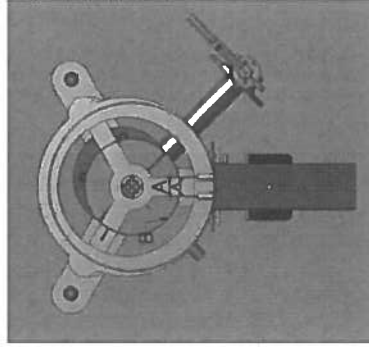

Fig. 19: Electrode distances

- Check the electrode distances (A and B), and if necessary readjust.
  - A = max. 8 mm / min. 5 mm
  - B = Electrodes must be placed inside the pipe B.

**Air supply**

- Check distance of air regulating disc (factory setting: 10mm)

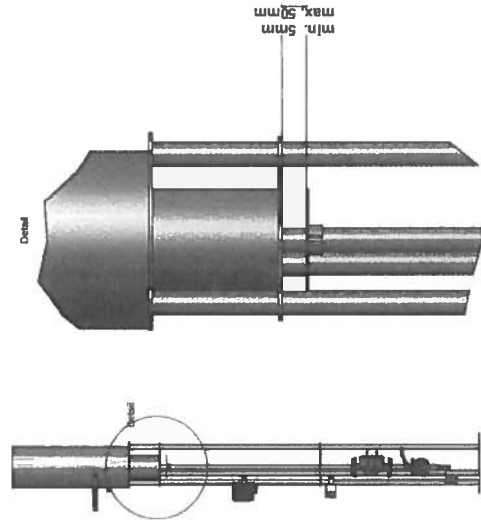

Fig 20: Air regulating disc

### Other necessary activities before initial start up

The following activities must be completed:

- Check the function of the condensate drain cock, and empty condensate. See also 11.5
- *Inspection and maintenance work.*
- All fastening parts used for the installation of the gas flare at the place of utilization must be checked, and if necessary tightened. Please observe the tightening torque of the respective fastening element. See 11.4 Torques. The flare body must be firmly anchored and tightened using three steel ropes.
- Make sure that all safety equipment such as protective covers, emergency switch/bulbion (formerly emergency shut-off), main switch etc. are available, correctly installed, and are functioning.
- Check the gas flare for visible damage and immediately remove the defects noted. The gas flare may only be operated if in perfect condition!
- Check the marked protective area to make sure that it is free of
  - people or vehicles and
  - dangerous materials and substances,
  - no objects (e.g. curtains, flags, birds' nests, etc) could blow or walk from the buildings or building parts into the protective area.
- Remove all objects and other materials not needed for operation from the work area.
- Check and make sure that the electrical connection was made according to the valid provisions. The cable feed through must be tightly screwed in and water tight.
- Make sure that all components for ensuring the potential equalization are correctly attached as specified in DIN or the EC guidelines, and were checked by the electrical engineer.
- Check and make sure that the gas connection was made according to the valid provisions.
- Make sure that an adequate quality of gas is available. The quantity, quality and pressure is prevalent for proper operation.

### HINWEIS

The minimum gas quantity required to start up the gas flare can be obtained from the technical data of the gas flare according to data table 7.2 or the "project specific data sheet" in the Annex.

## 9. START UP AND OPERATION

### ⚠ GEFAHR

**Danger of personal injury, property and environmental damage!**

*Please follow the safety instructions in Chapter 2. Safety.*

### 9.1 Initial start up

Before putting the gas flare into operation the first time,

- make sure you are well familiar with it:
- the equipment and operating elements, see under operation
- the measures in case of an emergency.
- Make sure that all control activities have been completed before initial start up. See 8.3. After installation and before initial start up.
- Complete the check list. See 12.2 Check list for initial start up .

Logs

- Document the first inspection of the gas seal and initial start up. See 12.3 Proof of repair work and leak tests.

## 9.2 Start-up

Only after you are convinced that the gas flare is ready for operation, can you put the gas flare into operation.

- Before connecting the supply voltage, check that...
  - the selector switch is off
  - the manual flap is open
  - the distance of the ignition electrodes is between 5 and 8 mm
  - the ignition electrodes are correctly positioned
  - there is enough gas in adequate quality available
- Turn the power supply on, i.e. turn on fuse. If necessary unlock emergency stop switch (previously emergency button).
- Make sure that the PLC control is set to "Run" (Optional).
- If the reset button/light is on (may be possible) - push to reset (confirm) (Optional).
- Check if...
  - the message from the flame indicator is in queue (check by using a lighter).
  - the function of the malfunction confirmation button
  - the function of the interfaces.

Conduct a test operation:

- Set the selector switch to MANUAL The automatic valve should open and after about two seconds ignition will start. VALVE OPEN lights up (optional).
- If the flare burns and the control light is on OPERATION, then one can assume that the confirmation ON of the gas flap works properly and the flare systems works. OPERATION only lights up if the flame monitoring detects a flame. After a few seconds the ignition stops (optional).
- Slowly close the manual flap until no more gas escapes. As soon as the flame is extinguished, the automatic flap must close immediately and after a few seconds the flare makes another attempt at starting. This will simulate non-combustible or too little gas.  
(If the flare malfunctions then all possible faults must be examined and removed. See 10.2 Troubleshooting).
- Turn the gas flare to AUTOMATIC to control operation externally (optional).

## 9.3 Operation

**Standard:**

After the flare started when pressing the ignition button ON, the button can be released. The flare will burn as long there is gas. If closing the butterfly valve, the flare will stop burning.

**OPTION: Automatic:**

After the ON request from the superior control or fill level contact on the gas storage has been issued, the operating cycle of the flare system will start (optionally the flare can also be operated with help from pressure switches).

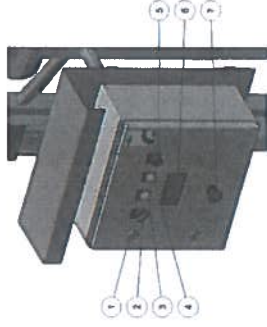

Fig. Z1: Gas flare FAI, switch cabinet

1. Switch cabinet lock
2. Mode selector switch
3. Signal lamp motor valve open
4. Signal lamp operation
5. Signal lamp error or reset button
6. Display
7. Emergency stop switch (previously emergency button)

**Ignition process**

First, the pneumatic or electrically operated gas flap is opened. At the same time the ignition transformer is activated, a ignition spark (electric arc) is generated above the flare burner and the continuous combustion of the gas is initiated.

Here, the flame is continuously monitored by a UV flame sensor. If a flame is detected, the ignition is shut off after a time delay of 10 seconds.

If no flame is detected over an ignition period of about 10 seconds, the ignition will stop and the automatic value will close momentarily.

If based on poor gas quality the flame stalls, the flare will attempt to ignite. If after five starting attempts a burning flame is still not detected, the flare will switch to malfunction.

If a flame is detected even though the flap is not opened, then the flare will switch to malfunction.



#### Pressure control (optional, only with automatic)

Via two pressure switches the turn-on and shut-off point for the flare is defined. Here the turn-on signal for the flare is generated by the pressure switch, and the ignition process runs automatically as described above. The pressure control functions via the control, if the selection switch is turned to AUTOMATIC.

Furthermore, the flare can be activated via an external starting signal or the manual control.

#### Operating mode ON/MANUAL (optional)

In this switch position, the ignition of the gas flare occurs the same way as in AUTOMATIC OPERATION. As a result, during start-up drive the gas can be manually burned off.

#### Operating mode OFF (optional)

In the OFF position of the switch attached to the switch cabinet, the burn off and ignition is not possible.

#### Air regulation:

To control the combustion air supply, there is one airregulating disc placed below the burner.

An adjustment of the airregulating disc is necessary if the flame burns unstable. That means:

- If the flame is strong and blows out based on the high flame speed, or burns far above the combustion chamber, then the airregulating disc must be closed.
- If the flame burns far below, directly on the burner, and if the combustion is instable, then more air is needed and the airregulating disc must be opened.

To adjust airregulating disc, proceed as follows:

- Turn the selection switch to FLARE OFF.
- Loosen counter nuts and slightly move airregulating disc
- Tighten the counter nuts again.

#### EMERGENCY STOP procedure

- Press the Emergency Stop switch to interrupt the supply voltage. The emergency stop switch catches and with a slight turn can be deactivated again.

#### Winter mode

See *Electrical heating of the valve route on page 22.*

#### HINWEIS

#### Communication

The flare control is designed to be directly incorporated in the control and visualization of the respective operating system (only if automatic option is chosen).

## 9.4 Taking out of operation

If the gas flare must be taken out of operation because of for example greater maintenance work, then only trained qualified employees who have read the operating manual and have the respective authorization can complete this work.

- Complete the following steps:
- Stop pressing the ignition button, Mode selector switch to "0"
- Engage the emergency stop switch
- Interrupt power supply (turn off fuse) and secure from restarting.
- Close butterfly valve

## 10. MALFUNCTIONS AND REMOVAL MALFUNCTIONS

### ⚠ GEFÄHR

#### Danger of personal injury, property and environmental damage!

Please follow the safety instructions in Chapter 2. Safety.

#### 10.1 Behaviour in case of malfunctions

- In case of malfunction of the electrical system or control units always contact EnvironTec GmbH or the biogas plant manufacturer.

You can reach us on business day from 8 am to 5 pm at +43 (0) 55 78 7 70 05 (outside of these hours leave a message on voicemail, fax or email). See contact information on page 2 of this document.

- In case of fire, immediately contact the fire department, Tel: 112!

For malfunctions that last more than 24 hours, suitable measures must be initiated such as reducing the feed quantities, so that the gas production is reduced, and it is no longer necessary to use the gas flare in continuous operation.

All spare parts (except for valves) can be obtained within one day by courier service. See 11.7 Spare parts.

### HINWEIS

Please inform us at any time about your system malfunctions. We depend on the experiences you make with the system, so that we can always make improvements.

#### 10.2 Troubleshooting

A majority of the malfunctions that occur can usually be attributed to a small error in the system of your system. Stay calm and think about the situation. Some malfunctions can easily be localized and removed if thinking about the problem logically.

For this purpose use the following list of malfunction messages.

For malfunctions that cannot easily be removed, please contact EnvironTec GmbH, or the manufacturer of the system in which the gas flare is installed.

Troubleshooting table

Malfunction	Possible cause	Measure
<b>General malfunctions</b>		
Power supply is interrupted or ready message is not seen	Fuse was triggered Power cable is defect Emergency stop switch was pressed	Check flare on site Loosen emergency off switch, check fuse Check power supply
Malfunction control	SPS is defect Switch is not in "Automatic" mode	Contact manufacturer and follows test instructions, Check flare
System is no longer technically sealed	Loose flange, defect seals, mechanical load Other exterior effects	Tighten flange connection, replace seals, check valves. Check, if mechanical forces are working (e.g. by setting the terrain, severe weather, etc.)
<b>Flame fault</b>		
Flame monitoring (UV sensor, flame detector) does not detect a flame after ignition process	Not enough gas, poor gas quality. Gas feed is interrupted UV sensor is dirty or defective, wiring error Defect high voltage line to the ignition electrodes or corroded plug. Distance between the electrodes (between 0.5 and 0.8 cm) Ignition transformer is defective	Test gas Check gas supply Clean UV sensor, check flame monitoring Check ignition Ignition electrodes - check distances and if necessary correct Check ignition transformer
After fifth successful ignition process, the flame stalls and burns for less than 30 seconds	Very poor gas quality Gas pressure is too high or too low Flame monitoring is defect	Test gas. Check gas supply Check flame monitoring
Even though the flap is closed, the flame is detected	Flame monitoring is defective, flap does not close	Check flame monitoring Check wiring
No ignition	Electrodes or cable or plug are defective	Check ignition

#### Fault acknowledgement (only if automatic option is choosen)

A malfunction is identified when the indicator light on the flare cabinet is lit and displays the message "Malfunction".

With the acknowledgment key on the switch cabinet (longer than 2 s), or the remote acknowledgement key (see communication), the occurring disturbance can be reset at any time.

## 11.1 MAINTENANCE

The maintenance measures include inspection, maintenance and repair.

### 11.1.1 Safety during maintenance



**Danger of personal injury, property and environmental damage!**

Please follow the safety instructions in Chapter 2. Safety.

**Warning of risk of explosion and flammable atmosphere!**

For maintenance work on the gas flare make sure that there is no potential explosive atmosphere while working!  
Only after turning off the affected system part can you work on the gas lines and the accumulated gas can be released and the system rinsed (inerting).  
Smoking is prohibited!

- ALWAYS use the relevant, required personal safety equipment (gas warning device, safety toe-cap shoes, safety gloves, hat, etc.)!
- All ignition sources (e.g. open flame, hot heat sources, not spark-free tools, not explosion protected electrical equipment, cell phones) MUST be kept away from the explosion area (ex zones)!
- ONLY use spark free tools (also applies to boring machines, drills, core drills, chisels, etc.)! Work that can generate weld, burn and sparks may NEVER be done in the vicinity of the explosion zones!

Before working on the electrical equipment

- Press and engage the emergency stop switch.
- Set mode selector switch to 0
- Interrupt power supply (turn off fuse) and secure from restarting.
- Close manual flap.
- Lock all work areas of the system, and make sure that no animals, children or unauthorized people are in the work area.

### 11.2 Record

The inspection and maintenance work, as well as sealing checks completed must be documented without fail. See 12.3 Proof of repair work and leak tests.

### 11.3 Inspection and maintenance plan

Intervals	Components	Check (for) / Activity	Operating resource / comments
Daily	All safety equipment, fasteners and electrical connections and lines	must be checked regularly for proper condition	If necessary, repair (have done). Replace defect parts (have done)
Weekly (depending on case)	Condensate discharge	Empty the condensate container	See under inspection and maintenance work
Monthly	Manual operation	Function	
Semi-annually	Flame monitoring Magnet/Enginevalve	Function, dirtying	
Annually	Piping connections	Visual check for leak tightness	With help from foaming material, ex. leakage detection spray for gas lines or a suitable gas detection device, a qualified person will check for leaks Record the results in a log
	Ignition electrodes	Distances of the electrodes	See 11.5 Inspection and maintenance work
As needed	Flame overvoltage protection (flame grid)	Check for corrosion, dirt and possible discoloration of the steel, which denotes deflagration	The check is performed by an authorised person
Every 3 years.	Switch cabinet and all electronic and electrical components	Clamps are stuck	See 11.5 Inspection and maintenance work

\*e.g. leak detector in the canister with frost protection according to DIN DVGW No. 8801 E 582 plus frost protection or in a spray can.

### 1.1.4 Torques

Information in Nm

To hold screws by tightening using the specified tension, they may only be tightened up to the maximum permitted tightening torque. If exceeding the tightening torque, the screw may stretch out and the tension force is lost.

Screw	M8	M10	M12	M16
Quality A2/A4-70	dry $\mu = 0.14$ 17.7	34.8	59.9	148
	Lubricated* $\mu = 0.10$ 13	28	45	105
Quality 8.8 zinc plated	dry $\mu = 0.14$ 25.4	49.5	85.2	211

\*lubricated with OKS white all-round or comparable lubricating agent.

### 1.1.5 Inspection and maintenance work

Interval: see *inspection and maintenance plan*

Drain condensate water



Explosion hazard because of gas escaping!

When opening the condensate water discharge drain, gas may escape

- Before opening the discharge drain, set the selection switch to FLARE OFF

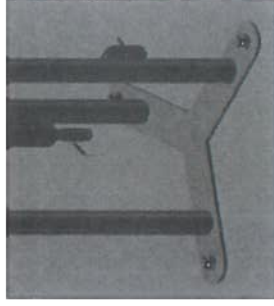

Fig. 22: Condensate water discharge drain

The discharge drain is located at the lowest point of the flare piping.

- Turn the selection switch to FLARE OFF.
- Place collecting tray beneath the drain.

- Open discharge drain and drain condensate container

**Ignition electrodes and flame sensor**



**Danger of surge**

See the safety precautions in 2 Safety

See also 11.5 Inspection and maintenance work – Before working on the electrical equipment.

**Clean ignition electrodes**



Fig. 23: Gas flare FAI, ignition electrodes

- Turn the selection switch to FLARE OFF.
- Carefully loosen the electrode bracket
- Remove existing deposits with a wire brush.
- Tighten electrode holder. **Caution!** Ceramic can easily break.

**Check ignition electrode distance**

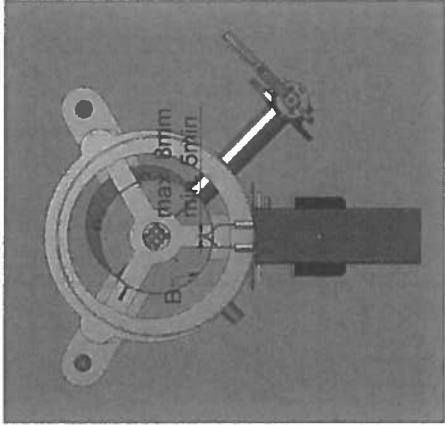

Fig. 23: gas flare FAI, check ignition electrode distance

If the distance of the ignition electrode is incorrect, then there is either not ignition spark or the ignition spark is too weak to ignite the gasses.

- Turn the selection switch to FLARE OFF.
- Carefully loosen the electrode container
- Check Electrode distance according to information in the illustration above. If necessary reset.
- Tighten electrode holder. **Caution!** Ceramic can easily break.

**Check flame sensor for function and cleanliness (optional)**

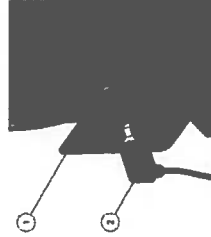

Fig. 24: Flame sensor (UV Sensor) with heat protection sign  
1 Heat protection sign 2 UV Sensor

- Remove sensor
- Check cleanliness of lense, if necessary clean with cloth and water.

### Flamearrestor and burner head

Check and clean flame backslash protection and burner head

For disassembly, maintenance and installation of the flame backslash protection, please see the respective instructions in the detail documentation (in the Annex under supporting documents). These must be checked periodically for functionality, especially if the flare is not being operated or only rarely.

#### Butterfly valve

- Turn the selection switch on the switch cabinet to OFF.
- Open and close the latching lever of the manual flap until stop and check free movement.
- Check for leaks using a leak detection agent.
- Watch for corrosion. For external corrosion, see manufacturer maintenance instructions.

### Motor valve/solenoid valve (Optional)

For disassembly, maintenance and installation of the motor valve, please see the respective instructions in the detail documentation (in Annex under supporting documentation)

### Switch cabinet, electronic and electric

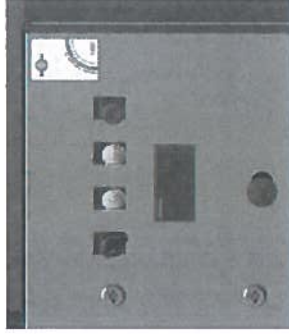

Fig. 25: Test plate on the switch cabinet

- Every 3 years check the switch cabinet and inspect all electronic and electrical components.
- Record the results in a log. Apply inspection sticker.

### 11.6 Restart

The following points must be followed, after concluding the maintenance work and before restarting the gas flare:

- Check again all previously loosened screw connections for a tight fit.
- Make sure that all previously removed protective installation, covers, etc. are installed again properly.
- Make sure that all the tools, materials and other equipment used are removed from the work area. Thereafter clean the work area.
- Make sure that all safety equipment is working properly again.

After completing the maintenance, the operator or service personnel must make sure that all work is completed and only then can the system be released for operation.

### 11.7 Spare and wearing parts

The lifetime of the wearing parts is depending of the hours of using the flare, weather conditions and temperature.

All spare and wearing parts can be obtained from EnvironTec GmbH upon request, and be delivered quickly by courier service.

To order spare parts for the gas flare, please contact us directly.

Please to speed up the ordering process, take note of the information of the flare's identification plate (e.g. The identification plate, serial number, year made).

### HINWEIS

We recommend keeping a spare part package on hand to allow immediate repairs.

See contact information on page 2 of this document.



### **12.3 Annexes**